



X-CON BRAND
CONDUCTIVE POLYMER ALUMINUM SOLID CAPACITORS
PRODUCT SPECIFICATION
規格書

| | |
|-----------------------------|------------------------------------|
| CUSTOMER : (客戶) : | DATE : (日期) : 2017-06-27 |
|-----------------------------|------------------------------------|

| | |
|------------------|--|
| CATEGORY (品名) | : CONDUCTIVE POLYMER ALUMINUM SOLID CAPACITORS |
| DESCRIPTION (型号) | : ULR 2.5V820 μ F (ϕ 6.3x8) |
| VERSION (版本) | : 01 |
| Customer P/N | : |
| SUPPLIER | : / |

| SUPPLIER | |
|-------------------------|------------------------|
| PREPARED (拟定) | CHECKED (审核) |
| 李婷 | 刘渭清 |

| CUSTOMER | |
|-------------------------|--------------------------|
| APPROVAL (批准) | SIGNATURE (签名) |
| | |

| | | |
|---|---|--------------|
| SAMXON ELECTRONIC COMPONENTS LIMITED | SOLID POLYMER CAPACITOR SPECIFICATION ULR SERIES | X-CON |
| | | |

| SPECIFICATION | | | | | ALTERNATION HISTORY RECORDS | | |
|---------------|------|------|------|----------|-----------------------------|--------|------|
| ULR SERIES | | | | | | | |
| Rev. | Date | Mark | Page | Contents | Purpose | Design | Cnfm |
| | | | | | | | |
| | | | | | | | |

| | | | | | | |
|-------------------------|------|---------------------------|------|---|--|--|
| Issued-date: 2017-06-27 | Name | Specification Sheet – ULR | | | | |
| Version | 01 | | Page | 1 | | |
| STANDARD MANUAL | | | | | | |

| | | |
|---|---|--------------|
| SAMXON ELECTRONIC COMPONENTS LIMITED | <i>SOLID POLYMER CAPACITOR SPECIFICATION ULR SERIES</i> | X-CON |
| | | |

CONTENTS

| | Sheet |
|---|--------------|
| 1. Application | 3 |
| 2. Part Number System | 3 |
| 3. Construction | 4 |
| 4. Characteristics | 5~11 |
| 4.1 Rated voltage & Surge voltage | |
| 4.2 Capacitance (Tolerance) | |
| 4.3 Leakage current | |
| 4.4 Tangent of loss angle | |
| 4.5 ESR | |
| 4.6 Temperature characteristic | |
| 4.7 Load life test | |
| 4.8 Surge test | |
| 4.9 Damp heat test | |
| 4.10 Maximum permissible ripple current | |
| 4.11 Rapid change of temperature | |
| 4.12 Lead strength | |
| 4.13 Resistance to vibration | |
| 4.14 Solderability | |
| 4.15 Resistance to soldering heat | |
| 5. Product Marking | 12 |
| 6. Product Dimensions, Impedance & Maximum Permissible Ripple Current | 13 |
| 7. Forming Dimension | 14 |
| 8. Application Guideline | 15~16 |
| 8-1 Circuit design | |
| 8-2 Voltage | |
| 8-3 Sudden charge and discharge restricted | |
| 8-4 Ripple current | |
| 8-5 Leakage current | |
| 8-6 Failure rate | |
| 8-7 Capacitor insulation | |
| 8-8 Precautions for using capacitors | |
| 9. Long Term Storage | |
| 10. Mounting Precautions | 16 |
| 11. List of "Environment-related Substances to be Controlled ('Controlled Substances')" | 17 |

| | | | | |
|-------------------------|------|---------------------------|------|---|
| Issued-date: 2017-06-27 | Name | Specification Sheet – ULR | | |
| Version | 01 | | Page | 2 |
| STANDARD MANUAL | | | | |

1. Application

This specification applies to conductive polymer aluminum solid capacitors used in electronic equipment.

2. Part Number System

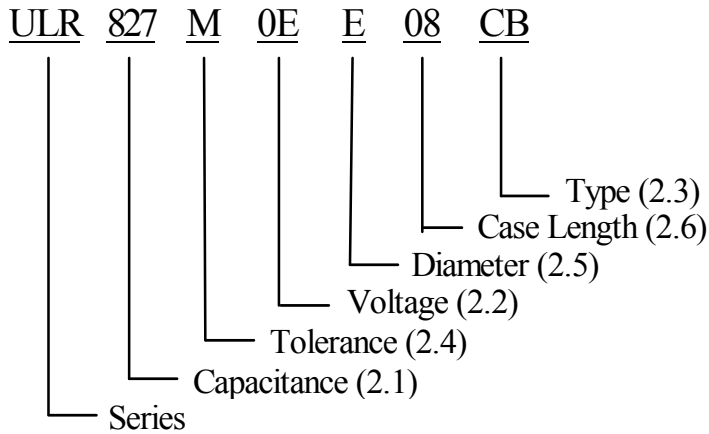

2.1 Capacitance code

| | |
|-------------------|------------|
| Code | 827 |
| Capacitance (μ F) | 820 |

2.2 Rated voltage code

| | |
|----------------|-----------|
| Code | 0E |
| Voltage (W.V.) | 2.5 |

2.3 Type

| | |
|-------------|---------------|
| Code | CB |
| Type | Forming Spec. |

2.4 Capacitance tolerance

“M” stands for -20% ~ +20%

2.5 Diameter

| | |
|-------------|----------|
| Code | E |
| Diameter | 6.3 |

2.6 Case length

08=8mm

3. Construction

Single ended type to be produced to fix the terminals to anode and cathode foil, and wind together with paper, and then wound element to be formed and carbonized, impregnated with polymer and polymerized, then will be enclosed in an aluminum case. Finally sealed up tightly with end seal rubber.

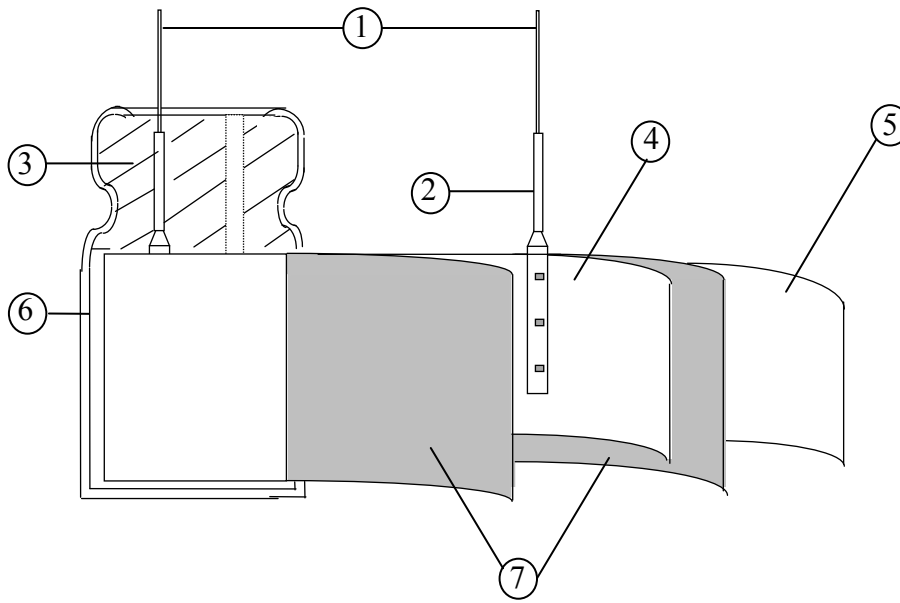

| No | Component | Material |
|----|-------------------|---|
| 1 | Lead Line | Tinned Copper Line or CP Line(Pb Free) |
| 2 | Terminal | Aluminum |
| 3 | Sealing Material | Rubber |
| 4 | Al-Foil (+) | Aluminum |
| 5 | Al-Foil (-) | Aluminum |
| 6 | Case | Aluminum |
| 7 | Electrolyte paper | Manila Hemp |

| | | | |
|---|---|--------------|--|
| SAMXON ELECTRONIC COMPONENTS LIMITED | <i>SOLID POLYMER CAPACITOR SPECIFICATION ULR SERIES</i> | X-CON | |
| | | | |

4. Characteristics

Standard atmospheric conditions

Unless otherwise specified, the standard range of atmospheric conditions for making measurements and tests is as follows:

Ambient temperature: 15°C to 35°C
 Relative humidity : 45% to 75%
 Air Pressure : 86kPa to 106kPa

If there is any doubt about the results, measurement shall be made within the following conditions:

Ambient temperature: 20°C ± 2°C
 Relative humidity : 60% to 70%
 Air Pressure : 86kPa to 106kPa

Operating temperature range

The ambient temperature range at which the capacitor can be operated continuously at rated voltage is -55°C to 105°C.

| | | | | |
|-------------------------|------|---------------------------|------|---|
| Issued-date: 2017-06-27 | Name | Specification Sheet – ULR | | |
| Version | 01 | | Page | 5 |
| STANDARD MANUAL | | | | |

| | | |
|---|---|--------------|
| SAMXON ELECTRONIC COMPONENTS LIMITED | <i>SOLID POLYMER CAPACITOR SPECIFICATION ULR SERIES</i> | X-CON |
| | | |

| ITEM | | PERFORMANCE | | | | |
|---------------------|---------------------------------------|--|---------------------|-----|--------------|------|
| 4.1 | Rated voltage (WV) | <table border="1" style="margin-left: auto; margin-right: auto;"> <tr> <td style="text-align: center;">WV (V.DC)</td> <td style="text-align: center;">2.5</td> </tr> <tr> <td style="text-align: center;">SV (V.DC)</td> <td style="text-align: center;">2.8</td> </tr> </table> | WV (V.DC) | 2.5 | SV (V.DC) | 2.8 |
| | WV (V.DC) | 2.5 | | | | |
| SV (V.DC) | 2.8 | | | | | |
| | Surge voltage (SV) | | | | | |
| 4.2 | Nominal capacitance (Tolerance) | <p><Condition> Measuring Frequency : 120Hz± 12Hz Measuring Voltage : Not more than 0.5Vrms +0.5~1.0V.DC Measuring Temperature : 20±2℃</p> <p><Criteria> Shall be within the specified capacitance tolerance.</p> | | | | |
| 4.3 | Leakage current | <p><Condition> After DC Voltage is applied to capacitors through the series protective resistor (1kΩ ± 10Ω) so that terminal voltage may reach the rated voltage. The leakage current when measured after 2 minutes shall not exceed the values of the following equation. In case leakage current value exceed the value shown in Table 3, remeasure after voltage treatment that applies the rated voltage shown in 4.1 for 120minutes at 105℃</p> <p><Criteria> See Table 3</p> | | | | |
| 4.4 | tan δ | <p><Condition> See 4.2, for measuring frequency, voltage and temperature.</p> <p><Criteria></p> <table border="1" style="margin-left: auto; margin-right: auto;"> <tr> <td style="text-align: center;">Working voltage (v)</td> <td style="text-align: center;">2.5</td> </tr> <tr> <td style="text-align: center;">tan δ (max.)</td> <td style="text-align: center;">0.10</td> </tr> </table> | Working voltage (v) | 2.5 | tan δ (max.) | 0.10 |
| Working voltage (v) | 2.5 | | | | | |
| tan δ (max.) | 0.10 | | | | | |
| 4.5 | ESR | <p><Condition> Measuring frequency : 100kHz to 300kHz; Measuring temperature:20±2℃ Measuring point : 2mm max from the surface of a sealing resin on the lead wire.</p> <p><Criteria> (20℃)Less than the initial limit(See Table 3).</p> | | | | |

| | | | |
|-------------------------|------|---------------------------|---|
| Issued-date: 2017-06-27 | Name | Specification Sheet – ULR | |
| Version | 01 | Page | 6 |
| STANDARD MANUAL | | | |

| 4.6 | Temperature characteristic | <p><Condition></p> <table border="1" style="width: 100%; border-collapse: collapse;"> <thead> <tr> <th style="width: 10%;">STEP</th> <th style="width: 20%;">Temperature(°C)</th> <th style="width: 30%;">Item</th> <th style="width: 40%;">Characteristics</th> </tr> </thead> <tbody> <tr> <td style="text-align: center;">1</td> <td style="text-align: center;">20±2</td> <td>Measure: Capacitance、 tanδ、 Impedance</td> <td style="text-align: center;">-----</td> </tr> <tr> <td style="text-align: center;">2</td> <td style="text-align: center;">-55+3</td> <td style="text-align: center;">Z-55°C / 20°C</td> <td style="text-align: center;">≤1.25</td> </tr> <tr> <td style="text-align: center;">3</td> <td style="text-align: center;">Keep at 15 to 35°C for 15 minutes or more</td> <td style="text-align: center;">-----</td> <td style="text-align: center;">-----</td> </tr> <tr> <td style="text-align: center;">4</td> <td style="text-align: center;">105±2</td> <td style="text-align: center;">Z105°C / 20°C</td> <td style="text-align: center;">≤1.25</td> </tr> <tr> <td rowspan="2" style="text-align: center;">5</td> <td rowspan="2" style="text-align: center;">20±2</td> <td style="text-align: center;">Δ C/C 20°C</td> <td style="text-align: center;">Within ± 5% of step1</td> </tr> <tr> <td style="text-align: center;">tanδ</td> <td style="text-align: center;">Less than or equal to the value of item 4.4</td> </tr> </tbody> </table> <p>a. Z -55°C or 105°C / Z 20°C: impedance ratio at 100kHz; b. Δ C/C 20°C: Capacitance change at 120Hz; c. tan δ at 120Hz.</p> | STEP | Temperature(°C) | Item | Characteristics | 1 | 20±2 | Measure: Capacitance、 tanδ、 Impedance | ----- | 2 | -55+3 | Z-55°C / 20°C | ≤1.25 | 3 | Keep at 15 to 35°C for 15 minutes or more | ----- | ----- | 4 | 105±2 | Z105°C / 20°C | ≤1.25 | 5 | 20±2 | Δ C/C 20°C | Within ± 5% of step1 | tanδ | Less than or equal to the value of item 4.4 |
|--------------------|--|--|--|-----------------|--------------------|-------------------------------------|-------|--|--|--|-----------------|---|---------------|-------------------------------------|---|--|-------|-------|---|-------|---------------|-------|---|------|------------|----------------------|------|--|
| STEP | Temperature(°C) | Item | Characteristics | | | | | | | | | | | | | | | | | | | | | | | | | |
| 1 | 20±2 | Measure: Capacitance、 tanδ、 Impedance | ----- | | | | | | | | | | | | | | | | | | | | | | | | | |
| 2 | -55+3 | Z-55°C / 20°C | ≤1.25 | | | | | | | | | | | | | | | | | | | | | | | | | |
| 3 | Keep at 15 to 35°C for 15 minutes or more | ----- | ----- | | | | | | | | | | | | | | | | | | | | | | | | | |
| 4 | 105±2 | Z105°C / 20°C | ≤1.25 | | | | | | | | | | | | | | | | | | | | | | | | | |
| 5 | 20±2 | Δ C/C 20°C | Within ± 5% of step1 | | | | | | | | | | | | | | | | | | | | | | | | | |
| | | tanδ | Less than or equal to the value of item 4.4 | | | | | | | | | | | | | | | | | | | | | | | | | |
| 4.7 | Load life test | <p><Condition> The Capacitor is stored at a temperature of 105 ± 2 °C with rated voltage for 2000 +48/0 hours. The result should meet the following table:</p> <p><Criteria></p> <table border="1" style="width: 100%; border-collapse: collapse;"> <thead> <tr> <th style="width: 40%;">Item</th> <th style="width: 60%;">Performance</th> </tr> </thead> <tbody> <tr> <td>Capacitance Change</td> <td>Within ± 20% of initial capacitance</td> </tr> <tr> <td>tan δ</td> <td>Less than or equal to 1.5 times of the value of item 4.4</td> </tr> <tr> <td>ESR</td> <td>Less than or equal to 1.5 times of the value of item 4.5</td> </tr> <tr> <td>Leakage current</td> <td>Less than or equal to the value of item 4.3</td> </tr> <tr> <td>Appearance</td> <td>Notable changes shall not be found.</td> </tr> </tbody> </table> | Item | Performance | Capacitance Change | Within ± 20% of initial capacitance | tan δ | Less than or equal to 1.5 times of the value of item 4.4 | ESR | Less than or equal to 1.5 times of the value of item 4.5 | Leakage current | Less than or equal to the value of item 4.3 | Appearance | Notable changes shall not be found. | | | | | | | | | | | | | | |
| Item | Performance | | | | | | | | | | | | | | | | | | | | | | | | | | | |
| Capacitance Change | Within ± 20% of initial capacitance | | | | | | | | | | | | | | | | | | | | | | | | | | | |
| tan δ | Less than or equal to 1.5 times of the value of item 4.4 | | | | | | | | | | | | | | | | | | | | | | | | | | | |
| ESR | Less than or equal to 1.5 times of the value of item 4.5 | | | | | | | | | | | | | | | | | | | | | | | | | | | |
| Leakage current | Less than or equal to the value of item 4.3 | | | | | | | | | | | | | | | | | | | | | | | | | | | |
| Appearance | Notable changes shall not be found. | | | | | | | | | | | | | | | | | | | | | | | | | | | |

| 4.8 | Surge test | <p><Condition> Capacitor shall be applied the surge voltage through 1kΩ resistor in series for 30±5 seconds in every 5minutes30S at 15~35℃. Procedure shall be repeated 1000 times. Then the capacitors shall be left under normal humidity for 1-2hours before measurement.</p> <p><Criteria></p> <table border="1" style="width: 100%; border-collapse: collapse;"> <thead> <tr> <th style="width: 50%;">Item</th> <th>Performance</th> </tr> </thead> <tbody> <tr> <td>Capacitance Change</td> <td>Within ±20% of initial capacitance</td> </tr> <tr> <td>tan δ</td> <td>Less than or equal to 1.5 times of the value of item 4.4</td> </tr> <tr> <td>ESR</td> <td>Less than or equal to 1.5 times of the value of item 4.5</td> </tr> <tr> <td>Leakage current</td> <td>Less than or equal to the value of item 4.3</td> </tr> </tbody> </table> <p>Attention: This test simulates over voltage at abnormal situation, and not be hypothesizing that over voltage is always applied.</p> | Item | Performance | Capacitance Change | Within ±20% of initial capacitance | tan δ | Less than or equal to 1.5 times of the value of item 4.4 | ESR | Less than or equal to 1.5 times of the value of item 4.5 | Leakage current | Less than or equal to the value of item 4.3 | | |
|--------------------|--|--|------|-------------|--------------------|------------------------------------|-------|--|-----|--|-----------------|---|------------|-------------------------------------|
| Item | Performance | | | | | | | | | | | | | |
| Capacitance Change | Within ±20% of initial capacitance | | | | | | | | | | | | | |
| tan δ | Less than or equal to 1.5 times of the value of item 4.4 | | | | | | | | | | | | | |
| ESR | Less than or equal to 1.5 times of the value of item 4.5 | | | | | | | | | | | | | |
| Leakage current | Less than or equal to the value of item 4.3 | | | | | | | | | | | | | |
| 4.9 | Damp heat test | <p><Condition> Humidity Test: The capacitor shall be exposed for 1000±48 hours in an atmosphere of 90~95%RH at 60±2℃, the characteristic change shall meet the following requirement.</p> <p><Criteria></p> <table border="1" style="width: 100%; border-collapse: collapse;"> <thead> <tr> <th style="width: 50%;">Item</th> <th>Performance</th> </tr> </thead> <tbody> <tr> <td>Capacitance Change</td> <td>Within ±20% of initial capacitance</td> </tr> <tr> <td>tan δ</td> <td>Less than or equal to 1.5 times of the value of item 4.4</td> </tr> <tr> <td>ESR</td> <td>Less than or equal to 1.5 times of the value of item 4.5</td> </tr> <tr> <td>Leakage current</td> <td>Less than or equal to the value of item 4.3</td> </tr> <tr> <td>Appearance</td> <td>Notable changes shall not be found.</td> </tr> </tbody> </table> | Item | Performance | Capacitance Change | Within ±20% of initial capacitance | tan δ | Less than or equal to 1.5 times of the value of item 4.4 | ESR | Less than or equal to 1.5 times of the value of item 4.5 | Leakage current | Less than or equal to the value of item 4.3 | Appearance | Notable changes shall not be found. |
| Item | Performance | | | | | | | | | | | | | |
| Capacitance Change | Within ±20% of initial capacitance | | | | | | | | | | | | | |
| tan δ | Less than or equal to 1.5 times of the value of item 4.4 | | | | | | | | | | | | | |
| ESR | Less than or equal to 1.5 times of the value of item 4.5 | | | | | | | | | | | | | |
| Leakage current | Less than or equal to the value of item 4.3 | | | | | | | | | | | | | |
| Appearance | Notable changes shall not be found. | | | | | | | | | | | | | |

| 4.10 | Maximum permissible (ripple current) | <p><Condition> The maximum permissible ripple current is the maximum A.C current At 100kHz and can be applied at maximum operating temperature see Table 3 The combined value of D.C voltage and the peak A.C voltage shall not exceed the rated voltage and shall not reverse voltage.</p> <p>Frequency Multipliers:</p> <table border="1" style="margin-left: auto; margin-right: auto;"> <tr> <td style="text-align: center;">Frequency</td> <td style="text-align: center;">$120\text{Hz} \leq f < 1\text{kHz}$</td> <td style="text-align: center;">$1\text{kHz} \leq f < 10\text{kHz}$</td> <td style="text-align: center;">$10\text{kHz} \leq f < 100\text{kHz}$</td> <td style="text-align: center;">$100\text{kHz} \leq f < 500\text{kHz}$</td> </tr> <tr> <td style="text-align: center;">Coefficient</td> <td style="text-align: center;">0.05</td> <td style="text-align: center;">0.30</td> <td style="text-align: center;">0.70</td> <td style="text-align: center;">1.00</td> </tr> </table> | Frequency | $120\text{Hz} \leq f < 1\text{kHz}$ | $1\text{kHz} \leq f < 10\text{kHz}$ | $10\text{kHz} \leq f < 100\text{kHz}$ | $100\text{kHz} \leq f < 500\text{kHz}$ | Coefficient | 0.05 | 0.30 | 0.70 | 1.00 |
|--------------------|---|--|---------------------------------------|--|-------------------------------------|--|--|---|-----------------|---|------|------|
| Frequency | $120\text{Hz} \leq f < 1\text{kHz}$ | $1\text{kHz} \leq f < 10\text{kHz}$ | $10\text{kHz} \leq f < 100\text{kHz}$ | $100\text{kHz} \leq f < 500\text{kHz}$ | | | | | | | | |
| Coefficient | 0.05 | 0.30 | 0.70 | 1.00 | | | | | | | | |
| 4.11 | Rapid change of temperature | <p>Applied voltage: without load Cycle number: 5 cycles Test diagram: Fig.1</p> <div style="text-align: center;"> </div> <p>Performance: The capacitors shall meet the following specification after 5 cycles.</p> <table border="1" style="margin-left: auto; margin-right: auto;"> <thead> <tr> <th style="text-align: center;">Item</th> <th style="text-align: center;">Performance</th> </tr> </thead> <tbody> <tr> <td style="text-align: center;">Capacitance change</td> <td style="text-align: center;">Within $\pm 10\%$ of initial capacitance</td> </tr> <tr> <td style="text-align: center;">$\tan \delta$</td> <td style="text-align: center;">Less than or equal to value of item 4.4</td> </tr> <tr> <td style="text-align: center;">Leakage current</td> <td style="text-align: center;">Less than or equal to the value of item 4.3 (after voltage treatment)</td> </tr> </tbody> </table> | Item | Performance | Capacitance change | Within $\pm 10\%$ of initial capacitance | $\tan \delta$ | Less than or equal to value of item 4.4 | Leakage current | Less than or equal to the value of item 4.3 (after voltage treatment) | | |
| Item | Performance | | | | | | | | | | | |
| Capacitance change | Within $\pm 10\%$ of initial capacitance | | | | | | | | | | | |
| $\tan \delta$ | Less than or equal to value of item 4.4 | | | | | | | | | | | |
| Leakage current | Less than or equal to the value of item 4.3 (after voltage treatment) | | | | | | | | | | | |

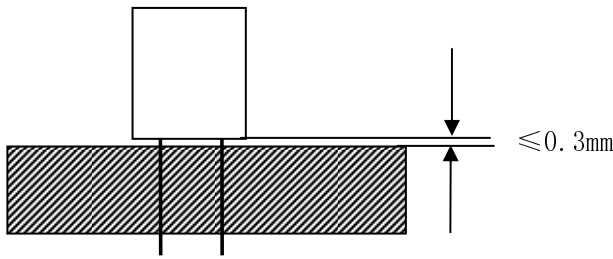
| 4.12 | Lead strength | <p>a) Lead pull strength A static load force shall be applied to the terminal in the axial direction and acting in a direction away from the body for 10 ± 1 s.</p> <table border="1" style="margin-left: auto; margin-right: auto;"> <tr> <th style="width: 60%;">Lead wire diameter (mm)</th> <th style="width: 40%;">Load force (N)</th> </tr> <tr> <td style="text-align: center;">$0.5 < d \leq 0.8$</td> <td style="text-align: center;">10</td> </tr> </table> <p>b) Lead bending When the capacitor is placed in a vertical position and the weight specified in the table above is applied to one lead and then the capacitor is slowly rotated 90° to a horizontal position and then returned to a vertical position thus completing bends for 2~3seconds. The additional bends are made in the opposite direction</p> <table border="1" style="margin-left: auto; margin-right: auto;"> <tr> <th style="width: 60%;">Lead wire diameter (mm)</th> <th style="width: 40%;">Load force (N)</th> </tr> <tr> <td style="text-align: center;">$0.5 < d \leq 0.8$</td> <td style="text-align: center;">5</td> </tr> </table> <p>Performance: The characteristic shall meet the following value after a) or b) test.</p> <table border="1" style="margin-left: auto; margin-right: auto;"> <tr> <th style="width: 50%;">Item</th> <th style="width: 50%;">Performance</th> </tr> <tr> <td>Leakage current</td> <td>Less than or equal to the value of item4.3</td> </tr> <tr> <td>Outward Appearance</td> <td>No cutting and slack of lead terminals</td> </tr> </table> | Lead wire diameter (mm) | Load force (N) | $0.5 < d \leq 0.8$ | 10 | Lead wire diameter (mm) | Load force (N) | $0.5 < d \leq 0.8$ | 5 | Item | Performance | Leakage current | Less than or equal to the value of item4.3 | Outward Appearance | No cutting and slack of lead terminals |
|-------------------------|--|---|-------------------------|----------------|--------------------|----|-------------------------|----------------|--------------------|---|------|-------------|-----------------|--|--------------------|--|
| Lead wire diameter (mm) | Load force (N) | | | | | | | | | | | | | | | |
| $0.5 < d \leq 0.8$ | 10 | | | | | | | | | | | | | | | |
| Lead wire diameter (mm) | Load force (N) | | | | | | | | | | | | | | | |
| $0.5 < d \leq 0.8$ | 5 | | | | | | | | | | | | | | | |
| Item | Performance | | | | | | | | | | | | | | | |
| Leakage current | Less than or equal to the value of item4.3 | | | | | | | | | | | | | | | |
| Outward Appearance | No cutting and slack of lead terminals | | | | | | | | | | | | | | | |
| 4.13 | Resistance to vibration | <p>Frequency: 10 to 55 Hz (1minute interval / 10 → 55 → 10Hz) Amplitude: 0.75mm(Total excursion 1.5mm) Direction :X、 Y、 Z (3 axes) Duration: 2hours/ axial (Total 6 hours) The capacitors are supported as the following Fig2</p> <div style="text-align: center;">  </div> <p style="text-align: center;">Fig2</p> <p>Performance: Capacitance value shall not show drastic change compared to the initial capacitance when the value is measured within 30 minutes. Prior to the completion of exam, Capacitance difference shall be within $\pm 5\%$ compared to the initial value the exam.</p> | | | | | | | | | | | | | | |

| 4.14 | Solderability | <p>The capacitor shall be tested under the following conditions:</p> <p>Solder : Sn-3Ag-0.5Cu Soldering temperature: 245±3°C Immersing time : 3±0.5s Immersing depth : 1.5~ 2.0mm from the root. Flux : Approx .25% rosin</p> <p>Performance: At least 95% of the dipped portion of the terminal shall be covered with new solder.</p> | | | | | | | | | | | | |
|--------------------|---|--|------|-------------|--------------------|-----------------------------------|-------|---|-----|---|-----------------|---|------------|-------------------------------------|
| 4.15 | Resistance to soldering heat | <p>A) Solder bath method Lead terminals of a capacitor are placed on the heat isolation board with thickness of 1.6±0.5mm. It will dip into the flux of isopropylalcohol solution of colophony. Then it will be immersed at the surface of the solder with the following condition: Solder : Sn-3Ag-0.5Cu Soldering temperature : 260 ±5°C Immersing time : 10±1s Heat protector: t=1.6mm glass –epoxy board</p> <p>B) Soldering iron method Bit temperature : 400 ±10°C Application time : 3+1/-0 s Heat protector: t=1.6mm glass –epoxy board</p> <p>For both methods, after the capacitor at thermal stability, the following items shall be measured:</p> <table border="1" style="width: 100%; border-collapse: collapse;"> <thead> <tr> <th style="width: 50%;">Item</th> <th style="width: 50%;">Performance</th> </tr> </thead> <tbody> <tr> <td>Capacitance Change</td> <td>Within ±5% of initial capacitance</td> </tr> <tr> <td>tan δ</td> <td>Less than or equal to the value of item 4.4</td> </tr> <tr> <td>ESR</td> <td>Less than or equal to the value of item 4.5</td> </tr> <tr> <td>Leakage current</td> <td>Less than or equal to the value of item 4.3 (after voltage treatment)</td> </tr> <tr> <td>Appearance</td> <td>Notable changes shall not be found.</td> </tr> </tbody> </table> | Item | Performance | Capacitance Change | Within ±5% of initial capacitance | tan δ | Less than or equal to the value of item 4.4 | ESR | Less than or equal to the value of item 4.5 | Leakage current | Less than or equal to the value of item 4.3 (after voltage treatment) | Appearance | Notable changes shall not be found. |
| Item | Performance | | | | | | | | | | | | | |
| Capacitance Change | Within ±5% of initial capacitance | | | | | | | | | | | | | |
| tan δ | Less than or equal to the value of item 4.4 | | | | | | | | | | | | | |
| ESR | Less than or equal to the value of item 4.5 | | | | | | | | | | | | | |
| Leakage current | Less than or equal to the value of item 4.3 (after voltage treatment) | | | | | | | | | | | | | |
| Appearance | Notable changes shall not be found. | | | | | | | | | | | | | |

5. Product Marking

Marking Sample:

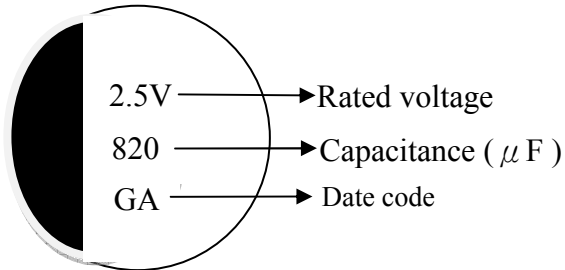

Table 1

| | | | | |
|------|------|------|------|------|
| Code | C | D | E | G |
| Year | 2013 | 2014 | 2015 | 2017 |

G A

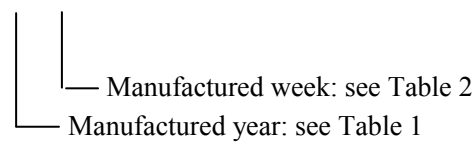
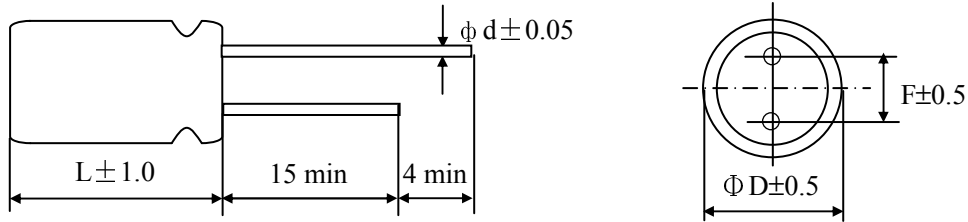

Table 2

| | | | | | | | | | | | |
|------|----------|----------|----------|----------|----------|----------|----------|----------|----------|----------|----------|
| Week | 1 | 2 | 3 | 4 | 5 | 6 | 7 | 8 | 9 | 10 | 11 |
| Code | A | B | C | D | E | F | G | H | I | J | K |
| Week | 12 | 13 | 14 | 15 | 16 | 17 | 18 | 19 | 20 | 21 | 22 |
| Code | L | M | N | O | P | Q | R | S | T | U | V |
| Week | 23 | 24 | 25 | 26 | 27 | 28 | 29 | 30 | 31 | 32 | 33 |
| Code | W | X | Y | Z | <u>A</u> | <u>B</u> | <u>C</u> | <u>D</u> | <u>E</u> | <u>F</u> | <u>G</u> |
| Week | 34 | 35 | 36 | 37 | 38 | 39 | 40 | 41 | 42 | 43 | 44 |
| Code | <u>H</u> | <u>I</u> | <u>J</u> | <u>K</u> | <u>L</u> | <u>M</u> | <u>N</u> | <u>O</u> | <u>P</u> | <u>Q</u> | <u>R</u> |
| Week | 45 | 46 | 47 | 48 | 49 | 50 | 51 | 52 | | | |
| Code | <u>S</u> | <u>T</u> | <u>U</u> | <u>V</u> | <u>W</u> | <u>X</u> | <u>Y</u> | <u>Z</u> | | | |

6. Product Dimensions, Impedance & Maximum Permissible Ripple Current
Unit: mm



| | |
|----------------------------|-----|
| ϕD | 6.3 |
| L | 8 |
| F | 2.5 |
| ϕd | 0.6 |

Table 3

| Working Voltage (V) | Capacitance (μF) | Dimension (D × L, mm) | Maximum permissible ripple current at 105°C 100kHz (mA rms) | ESR at 20°C 100kHz to 300kHz (mΩ) | Leakage current (μA) 2min |
|---------------------|-------------------------|-----------------------|---|-----------------------------------|----------------------------------|
| 2.5 | 820 | 6.3x8 | 5600 | 7 | 410 |

7. Forming Dimension

Unit: mm

| Shape Code | ϕD | $\phi 6.3$ |
|------------|----------|------------|
| CB | F | 2.5 |
| | H | 3.2 |
| | d | 0.6 |

CB Type

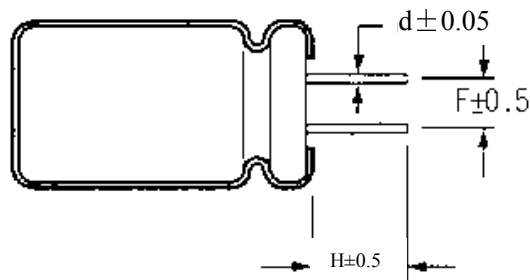

| | | |
|---|---|--------------|
| SAMXON ELECTRONIC COMPONENTS LIMITED | <i>SOLID POLYMER CAPACITOR SPECIFICATION ULR SERIES</i> | X-CON |
| | | |

8.Application Guideline:

X-CON Solid Aluminum Electrolytic Capacitor should be used compliance with the following guidelines

8-1 Circuit design

Prohibited Circuits for use

Do not use the capacitors with the following circuits.

- 1) Time constant circuits
- 2) Coupling circuits
- 3) Circuits which are greatly affected by leakage current
- 4) High impedance voltage retention circuits.

8-2. Voltage

1) Over voltage

The application of over-voltage and reverse voltage below can cause increases in leakage current and short circuits.

Applied voltage, refers to the voltage value including the peak value of the transitional instantaneous voltage and the peak Value of ripple voltage, not just steady line voltage. Design your circuit so that the peak voltage does not exceed the stipulated voltage.

Over voltage exceeding the rated voltage may not be applied even for an instant as it may cause a short circuit.

2) Applied voltage

- ① Sum of the DC voltage value and the ripple voltage peak values must not exceed the rated voltage.
- ② When DC voltage is low, negative ripple voltage peak value must not become a reverse voltage that exceeds 10% of The rated voltage.
- ③ Use the X-CON within 20%of the rated voltage for applications which may cause the reverse voltage during the Transient phenomena when the power is tumid off or the source is switched.

8-3 Sudden charge and discharge restricted

Sudden charge and discharge may result in short circuit’s large leakage current. Therefore, a protection circuits are recommended to design in when on of the following condition is expected.

- 1) The rush current exceeds 10A
- 2) The rush current exceeds 10 times of allowable ripple current of X-CON.

A protection resistor (1K Ω) must be inserted to the circuit during the charge and discharge when measuring the leakage Current.

8-4 Ripple current

Use the capacitors within the stipulated permitted ripple current. When excessive ripple current is applied to the capacitor, It causes increases in leakage current and short circuits due to self- heating. Even when using the capacitor under the Permissible ripple current, reverse voltage may occur if the DC bias voltage is low.

8-5 Leakage current

There is a risk of leakage current characteristics increasing even if the following use environments are within the stipulated range However, even if leakage current increases once, it has the characteristic that leakage current becomes small in most cases after voltage is applied due to its self-correction mechanism.

8-6 Failure rate

The main failure mode of X-CON is open mode primarily caused by electrostatic capacity drop at high temperature (i.e.wear out failure), besides random short circuit mode failures primarily caused by over voltage occurs as minor one.

The time it takes to reach the failures mode can be extended by using the X-CON with reduced ambient temperature, ripple current and applied voltage.

8-7 Capacitor insulation

- 1) Insulation in the marking sleeve is not guaranteed. Be aware that the space between the case and the negative electrode Terminal is not insulated and has some resistance.
- 2) Be sure to completely separate the case, negative lead terminal, and positive lead terminal and PCB patterns with each other.

| | | | | |
|-------------------------|------|---------------------------|------|----|
| Issued-date: 2017-06-27 | Name | Specification Sheet – ULR | | |
| Version | 01 | | Page | 15 |
| STANDARD MANUAL | | | | |

| | | | |
|---|---|--------------|--|
| SAMXON ELECTRONIC COMPONENTS LIMITED | <i>SOLID POLYMER CAPACITOR SPECIFICATION ULR SERIES</i> | X-CON | |
| | | | |

8-8 Precautions for using capacitors

X-CON capacitors should not be used in the following environments.

- 1) Environments where the capacitor is subject to direct contact with salt water or oil can directly fall on it.
- 2) Environments where capacitors are exposed to direct sunlight.
- 3) High temperature (Avoid locating heat generating components around the X-CON and on the underside of the PCB), or humid environments where condensation can form on the surface of the capacitor.
- 4) Environments where the capacitor is in contact with chemically active gases.
- 5) Acid or alkaline environments.
- 6) Environment subject to high-frequency induction.
- 7) Environment subject to excessive vibration and shock.

9. Long Term Storage

Store the X-CONs in sealed package bags after delivery per the table below;

| X-CON Type | Before unsealing |
|--|--|
| Radial lead type packed in bags | Must be used within 24~36 months after delivery(unsealed status) |
| Radial lead type packed in taping method | Must be used within 24~36 months after delivery(unsealed status) |

10. Mounting Precautions

| Mounting phase | Things to note before mounting | Disposal |
|-----------------|--|---|
| Before mounting | 1) Used X-CON capacitors | Not reused |
| | 2) LC-increased X-CON capacitors after long storage | Apply them with rated voltage in series with 1K Ω resistance for 1 hour at the range between 60 and 70°C |
| | 3) X-CON capacitors dropped to the floor | Not reused |
| | 4) Precautions on polar, capacitance and rated voltage | Products without remarkable polar, capacitance and rated voltage shouldn't be available |
| | 5) Precautions on the pitch between lead terminal and PCB | The products can be used only when said pitch is matched |
| | 6) Precautions on the stress that lead terminal and body of X-CON capacitors enduring in mounting | The products can be used for production only when lead terminal and body are not subject stress. |
| Mounting | 1) Soldering with a soldering iron | Both temperature and duration in mounting should meet the requirements of out-going SPEC; no stress should be allowed to occur in mounting; Don't let the tip of the soldering iron touch the X-CON itself. |
| | 2) Flow soldering | X-CON capacitor body should be prohibited to submerge in melted solder; both temperature and duration in mounting should meet the requirements of out-going SPEC; The rosin is not allowed to adhere to any where other than lead terminal. |
| After mounting | 1) Precautions on mounting status | Do not tilt, bend twists X-CON; Do not allow other matter touch X-CON. |
| | 2) Washing the PCB (available cleaning agent 1)high quality alcohol-based cleaning fluid such as st-100s、750L,750M;2) Detergents including substitute freon such as AK-225AES and IPA) | Used immersion or ultrasonic waves to clean for a total of less than 5 minutes and the temperature be less than 60°C; The conductivity, PH, specific gravity and water cleaning, X-CON products should be dried with hot air (less than the maximum operating temperature). |

| | | | | |
|-------------------------|------|---------------------------|----|--|
| Issued-date: 2017-06-27 | Name | Specification Sheet – ULR | | |
| Version | 01 | Page | 16 | |
| STANDARD MANUAL | | | | |

| | | | |
|---|---|-------|--|
| SAMXON ELECTRONIC COMPONENTS LIMITED | SOLID POLYMER CAPACITOR SPECIFICATION ULR SERIES | X-CON | |
| | | | |

11. It refers to the latest document of “Environment-related Substances standard”(WI-HSPM-QA-072).

| Substances | |
|--|--|
| Heavy metals | Cadmium and cadmium compounds |
| | Lead and lead compounds |
| | Mercury and mercury compounds |
| | Hexavalent chromium compounds |
| Chloinated organic compounds | Polychlorinated biphenyls (PCB) |
| | Polychlorinated naphthalenes (PCN) |
| | Polychlorinated terphenyls (PCT) |
| | Short-chain chlorinated paraffins(SCCP) |
| | Other chlorinated organic compounds |
| Brominated organic compounds | Polybrominated biphenyls (PBB) |
| | Polybrominated diphenylethers(PBDE) (including decabromodiphenyl ether[DecaBDE]) |
| | Other brominated organic compounds |
| Tributyltin compounds(TBT) | |
| Triphenyltin compounds(TPT) | |
| Asbestos | |
| Specific azo compounds | |
| Formaldehyde | |
| Polyvinyl chloride (PVC) and PVC blevds | |
| Beryllium oxide | |
| Beryllium copper | |
| Specific phthalates (DEHP,DBP,BBP,DINP,DIDP,DNOP,DNHP) | |
| Hydrofluorocarbon (HFC), Perfluorocarbon (PFC) | |
| Perfluorooctane sulfonates (PFOS) | |
| Specific Benzotriazole | |

| | | | |
|-------------------------|------|---------------------------|----|
| Issued-date: 2017-06-27 | Name | Specification Sheet – ULR | |
| Version | 01 | Page | 17 |
| STANDARD MANUAL | | | |